

Accessories

Front Panel Boot

Transparent covers for lighted pushbuttons (S-Series) and rocker switches (CRS and CRT Series) provide protection against dirt and contaminants. To order, add the suffix "-T" to the part number selected. To order separately, use the part number on the drawing below.

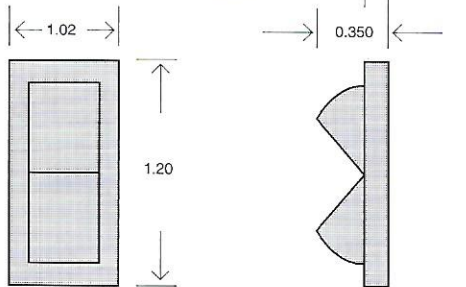
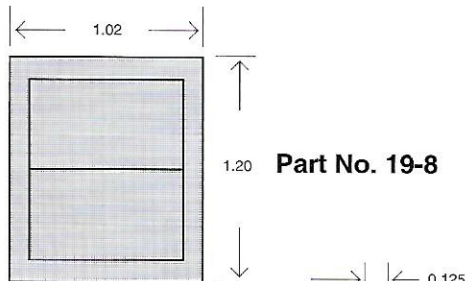
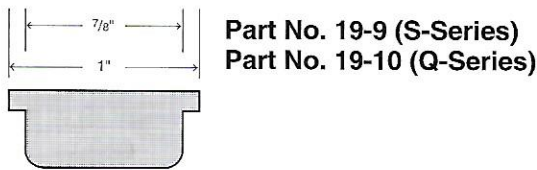
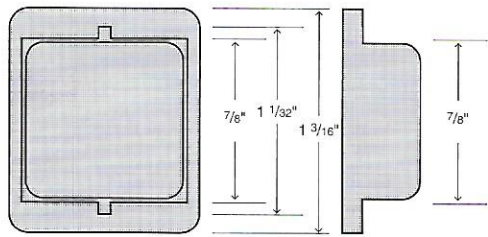

Part No. 19-7

Protective Barrier

Available on S Series Pushbutton Switches, and CTRL, CRTP and WRTP Series Rocker Switches.

The protective barrier is offered to help prevent accidental activation of the switch or adjacent switches (when matrix mounted).

To order, add the suffix "-B" to the part number selected. To order separately, use the part number on the drawing below.

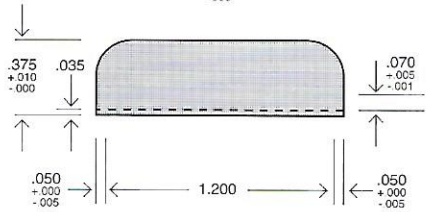
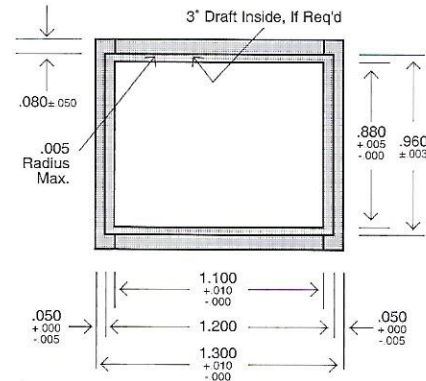

Part No. 19-6W9

Weatherproof Gasket

Available on W Series Rocker Switches.

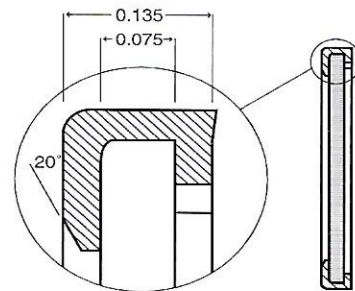

WRS Part No. 19-11

WRT Part No. 19-12