

2M Series Sub-Miniature Single Pole Toggle Switches

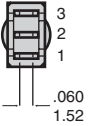
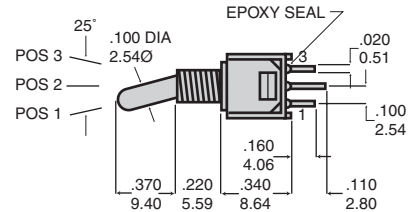
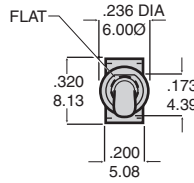

No. Poles	UL/CSA Model No.	Model No.	SWITCH FUNCTION			CONNECTED TERMINALS		
			Pos. 1	Pos. 2	Pos. 3	Pos. 1	Pos. 2	Pos. 3
SP	Q2211	2MS1	On	None	On		OPEN	
	Q2212	2MS2	On	None	Mom			
	Q2213	2MS3	On	Off	On			
	Q2214	2MS4	Mom	Off	Mom			
	Q2215	2MS5	On	Off	Mom			
	Q2216	2MS6	Off	None	On			

MOM=Momentary

Specifications

Contact Rating: Dependent upon contact material

Electrical Life: 30,000 make-and-brake cycles at full load.

Contact Resistance: 20m Ω max. initial @ 2-4VDC
100mA for both silver and gold plated contacts.

Insulation Resistance: 1,000M Ω min.

Dielectric Strength: 1000 V RMS@sea level

Operating Temperature: -30° C to 85° C

Materials

Case: Diallyl phthalate (DAP)(UL-94V-0)

Actuator: Brass, chrome plated

Bushing: Brass, nickel plated

Housing: Stainless Steel

Switch Support: Brass, tin plated

Terminals/Contact: Brass, with Silver or gold plated

Ordering Information

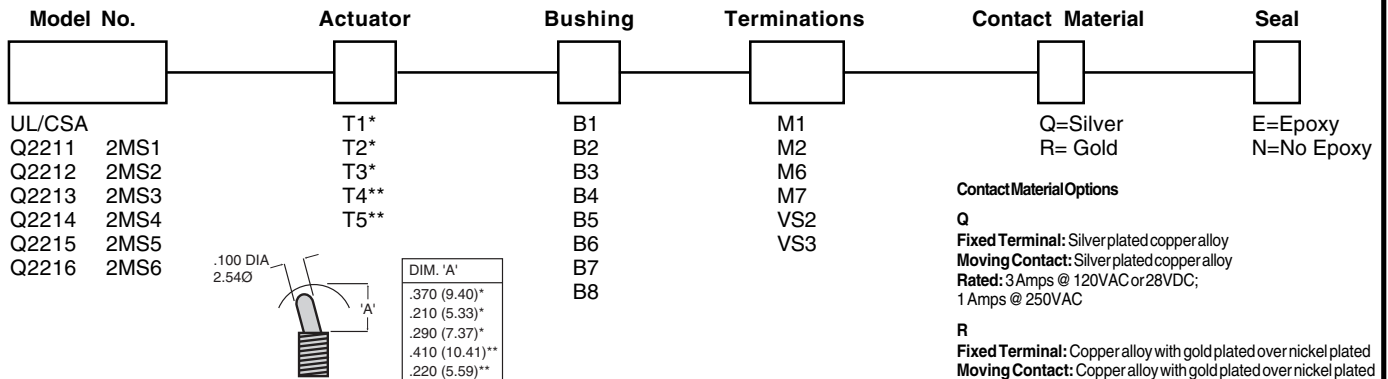

*Actuator shown with B1 or B3 bushing, subtract 0.09 (2.29) for B5 bushing, subtract 0.041 (1.02) for B7 bushing.
 **Actuator shown with B5 bushing, add 0.09 (2.29) for B1 and B3 bushing, add 0.05 (1.27) for B7 bushing.



Phone (203) 272-2794 • Fax (203) 272-3492 • <http://www.osloswitch.com>

MADE IN U.S.A.

2M Series Sub-Miniature Double Pole Toggle Switches

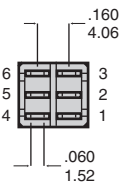
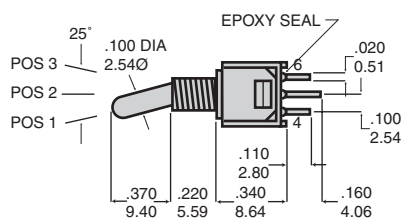
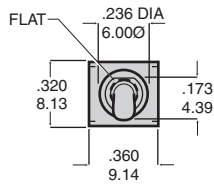
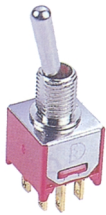

No. Poles	UL/CSA Model No.	Model No.	SWITCH FUNCTION			CONNECTED TERMINALS		
			Pos. 1	Pos. 2	Pos. 3	Pos. 1	Pos. 2	Pos. 3
DP	Q2221	2MD1	On	None	On		OPEN	
	Q2222	2MD2	On	None	Mom			
	Q2223	2MD3	On	Off	On			

MOM=Momentary

Specifications and Materials: See page 1.

Ordering Information

Model No.	Actuator	Bushing	Termination	Contact Material	Seal
<ul style="list-style-type: none"> UL/CSA Q2221 2MD1 Q2222 2MD2 Q2223 2MD3 	<ul style="list-style-type: none"> T1* T2* T3* T4** T5** 	<ul style="list-style-type: none"> B1 B2 B3 B4 B5 B6 B7 B8 	<ul style="list-style-type: none"> M1 M2 M6 M7 VS2 VS3 	<ul style="list-style-type: none"> Q=Silver R=Gold 	<ul style="list-style-type: none"> E=Epoxy N=No Epoxy

Contact Material Options

Q
Fixed Terminal: Silver plated copper alloy
Moving Contact: Silver plated copper alloy
Rated: 3Amps @ 120VAC or 28VDC;
 1Amps @ 250VAC

R
Fixed Terminal: Copper alloy with gold plated over nickel plated
Moving Contact: Copper alloy with gold plated over nickel plated
Rated: .04 VA max. @ 20VAC or DC MAX.

*Actuator shown with B1 or B3 bushing, subtract 0.09 (2.29) for B5 bushing, subtract 0.041 (1.02) for B7 bushing.
 **Actuator shown with B5 bushing, add 0.09 (2.29) for B1 and B3 bushing, add 0.05 (1.27) for B7 bushing.



Phone (203) 272-2794 • Fax (203) 272-3492 • <http://www.osloswitch.com>

2M Series Sub-Miniature Double Pole Toggle Switches

Bushing Options

B1 THD
B2 NON-THD

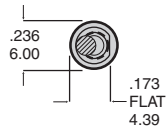

B3 THD
B4 NON-THD

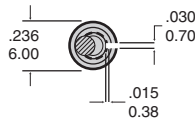

B1-B4

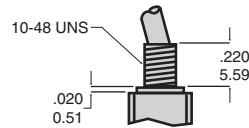

B5 THD
B6 NON-THD

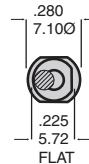

B7 THD
B8 NON-THD

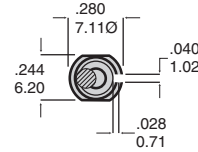

B5-B8

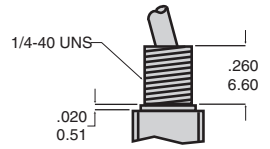

Panel Cutout

10-48 BUSHING

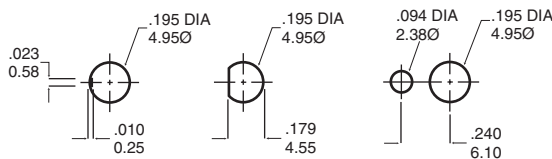

Without locking ring

With Std. locking ring

1/4 in. BUSHING

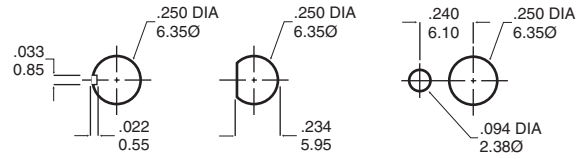

Without locking ring

With Std. locking ring

Termination Options

M1

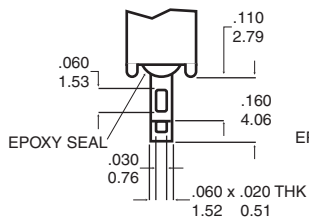

Single Pole

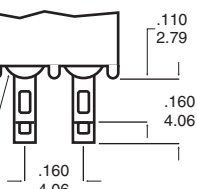

Double Pole

M2

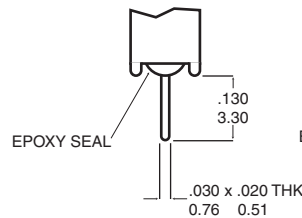

Single Pole

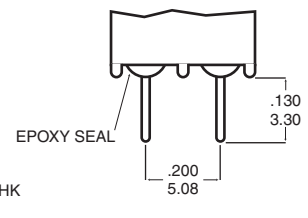

Double Pole

M6 SPDT

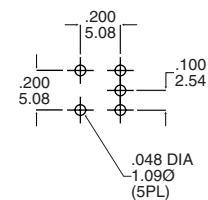
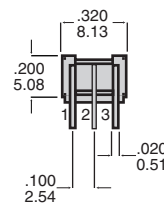
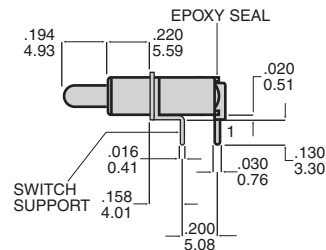
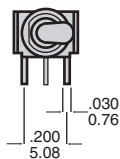

Phone (203) 272-2794 • Fax (203) 272-3492 • <http://www.osloswitch.com>

MADE IN U.S.A.

Termination Options (continued)

M6 DPDT

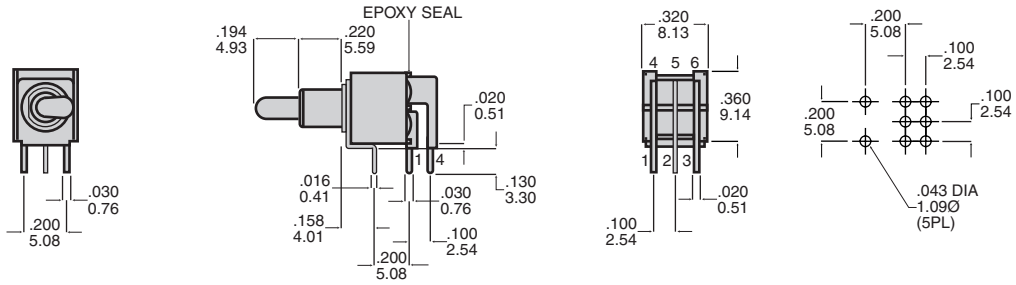

M7 SPDT

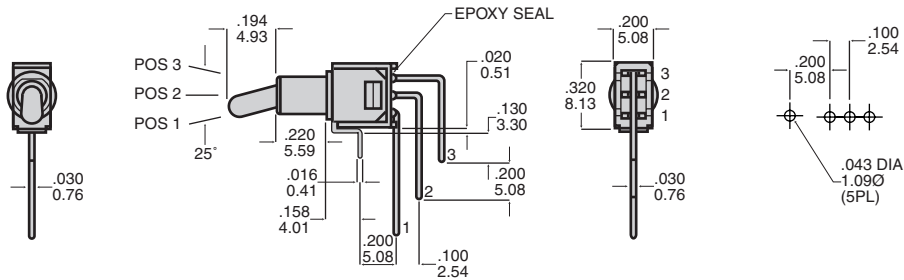

M7 DPDT

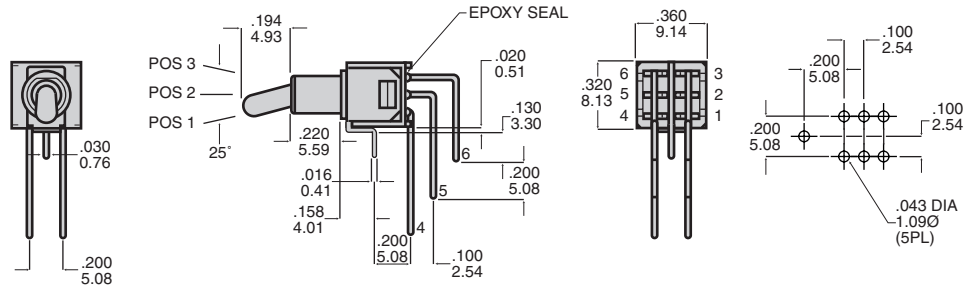

VS2 SPDT

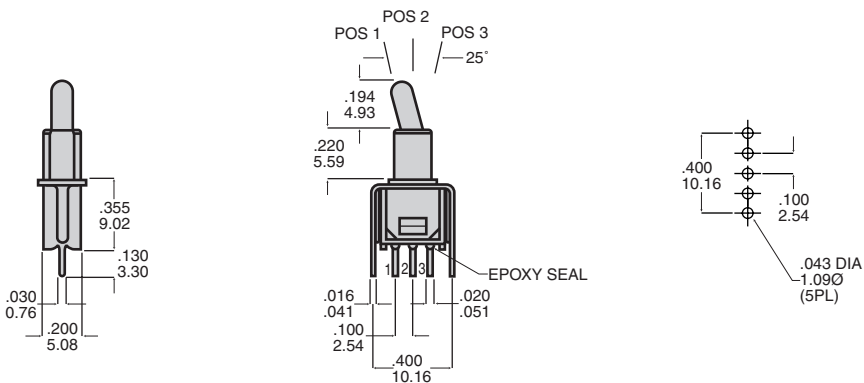

VS3 DPDT

