

# C RTP Series Non-lighted Single-pole Rocker Switches

## Approvals

UL recognized, CSA certified. Load rating: 20A 125/250 VAC. 1 HP, 125/250 VAC. 14A 14VDC, VDE approval 15A. Contacts: fine silver for long life dependability. Dielectric strength: 1250 volts (live parts to ground). Life: 35,000 operations at maximum rating. Insulation resistance: 5 megohms.

## Low Level Control

For low level/dry circuit applications (<100 am) contact factory for part number (Gold plated contacts).

## High Inrush

125 Amp inrush capability (AgNi contacts).

## Terminals

Style A - 1/4-inch quick-connect

## Mechanical Features





100,000 mechanical operations

## Markings

Letters, numbers and symbols can be applied to rocker actuator or to integral nylon bezel; see inside back cover for details.

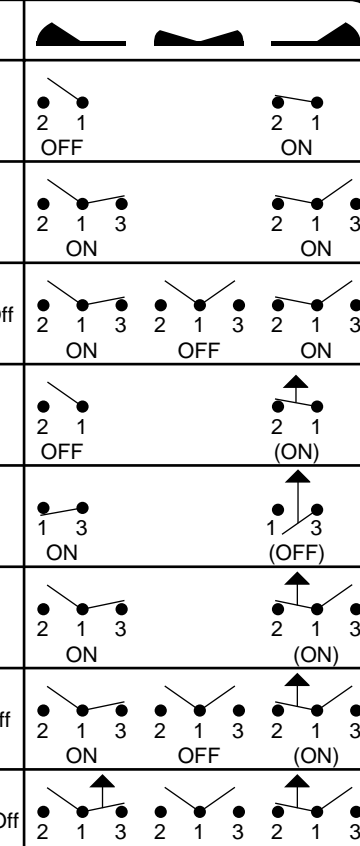
## Mounting

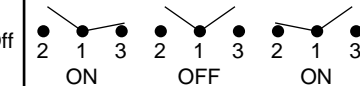
Snap-in type panel mounting for ease of installation without additional mounting hardware.

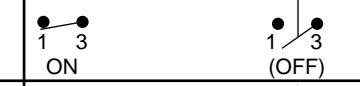
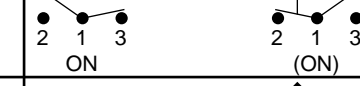
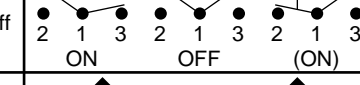
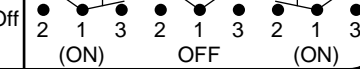
Circuit	Switching	
1	SPST Maintained	
2	SPDT Maintained	
3	SPDT Maintained Center Off	
4	SPST (Momentary) Normally Open	
5	SPDT (Momentary) Normally Closed	
6	SPDT (Momentary) Transfer	
7	SPDT Maintained Center Off (Momentary)	
8	SPDT (Momentary) Center Off (Momentary)	

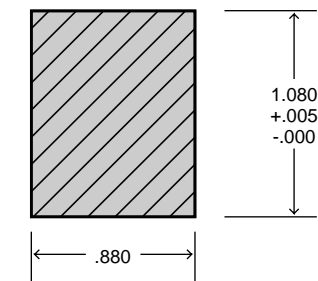
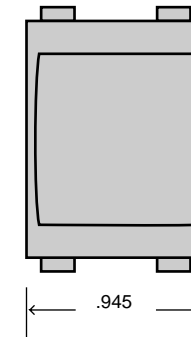
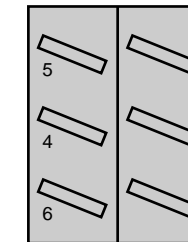
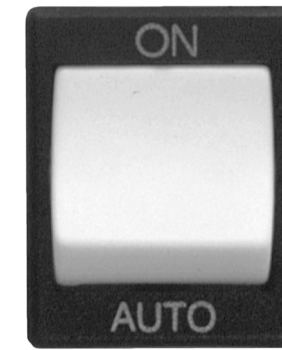
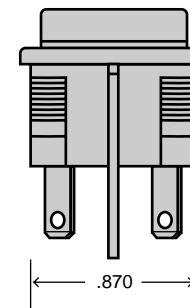
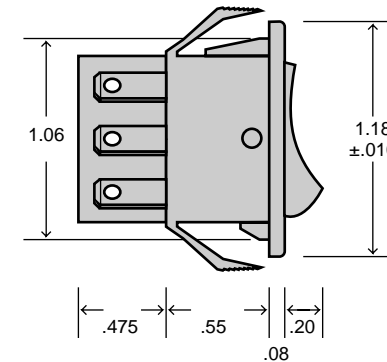

Panel Cut Out  
Panel Thickness 1/32" - 3/16"

## Ordering Information:

